



audio-technica

Check



Headphones



Charging case



Eartips (XS, S, M, L)



3D loop support



USB charging cable



Quick start guide (this leaflet)



Caution guide

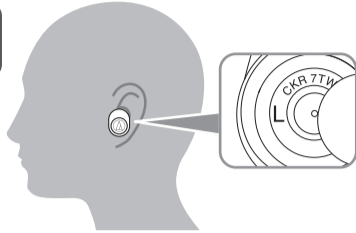

ATH-CKR7TW

Charge

Charging case

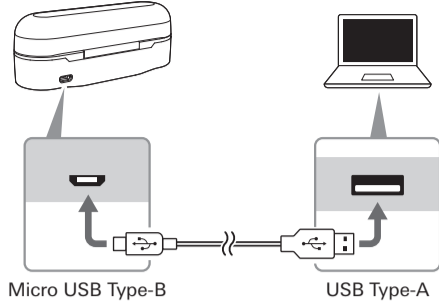

Micro USB Type-B

USB Type-A

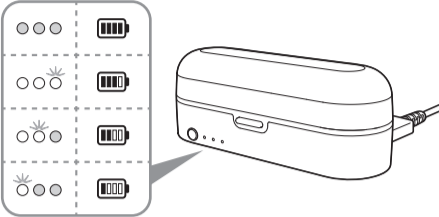

Headphones

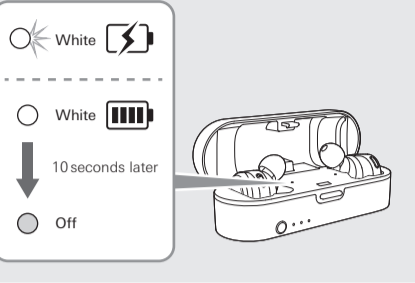
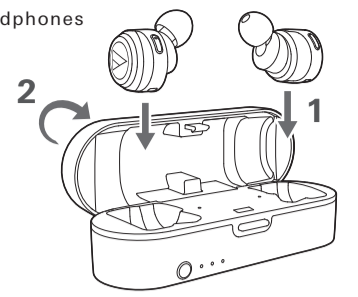

Pairing

1 ON

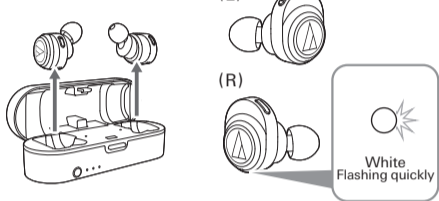

OFF

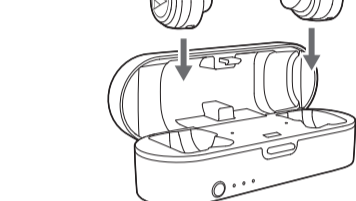

2

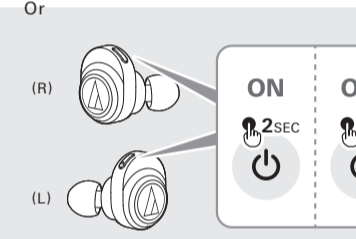
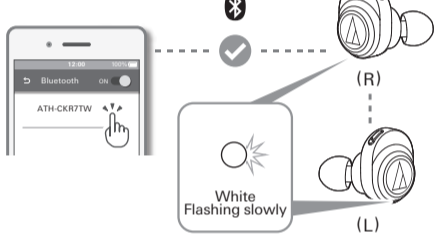

Music / Phone

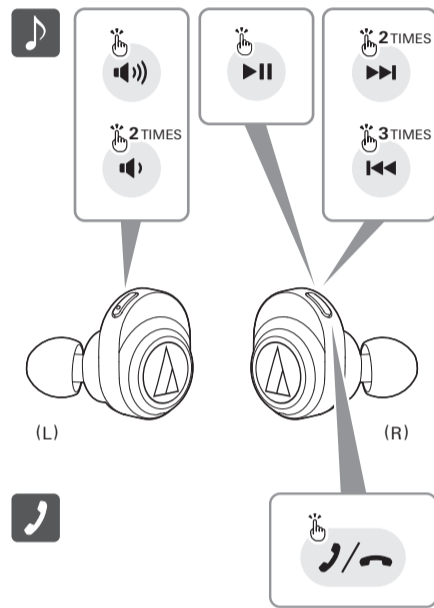

Information

For more information on how to use this product, visit the Audio-Technica website at the URL listed below and contained in the QR code.

www.audio-technica.com

To more conveniently use the product, use our app for smartphones.

Download on the **App Store**

GET IT ON **Google Play**

The Bluetooth® word mark and logos are owned by Bluetooth SIG, Inc. and any use of such marks by Audio-Technica Corporation is under license. All other trademarks are property of their respective owners.

Apple and the Apple logo are trademarks of Apple Inc., registered in the U.S. and other countries.

App Store is a service mark of Apple Inc.

Google Play and the Google Play logo are trademarks of Google LLC.

Audio-Technica Corporation
2-46-1 Nishi-naruse, Machida, Tokyo 194-8666, Japan
www.audio-technica.co.jp
©2018 Audio-Technica Corporation 132314110-01-01 ver.1 2018.11.01

Français / Deutsch / Italiano

Contrôle / Kontrolle / Controllo



Écouteurs / Kopfhörer / Cuffie



Étui chargeur / Ladegehäuse / Alloggiamento per la ricarica



Embout (TP, P, M, G) / Kopfhöreraufsätze (XS, S, M, L) / Copriauricolari (XS, S, M, L)



Support de boucle 3D / 3D-Loop-Support / Anello di supporto 3D



Câble de recharge USB / USB-Ladekabel / Cavo per la carica USB



Guide de prise en main (ce dépliant) / Kurzanleitung (dieser Handzettel) / Guida rapida (questo opuscolo)



Guide de mise en garde / Sicherheitsanweisungen / Guida precauzionale

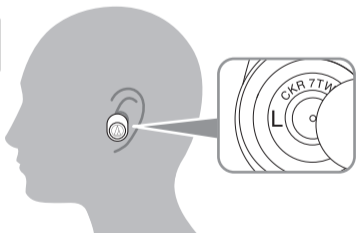

Charge / Laden / Carica

Étui chargeur / Ladegehäuse / Alloggiamento per la ricarica

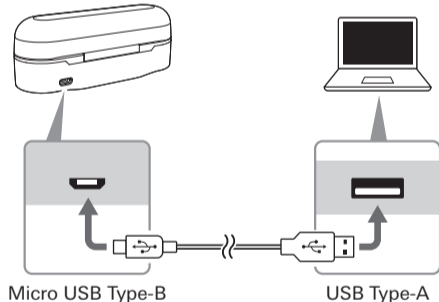

Micro USB Type-B

USB Type-A

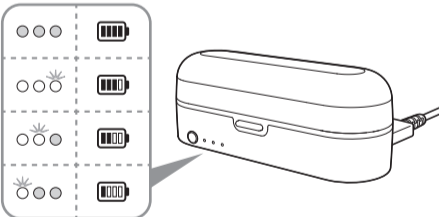

Écouteurs / Kopfhörer / Cuffie

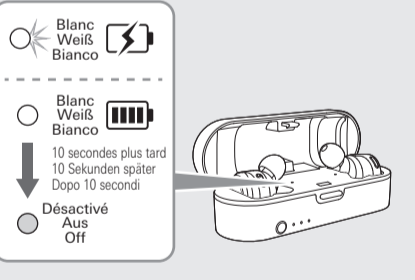
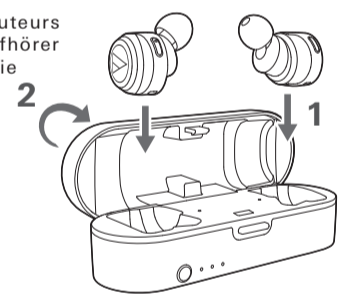

Appairage / Paarung / Associazione

1 ON

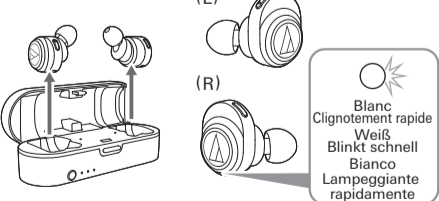

OFF

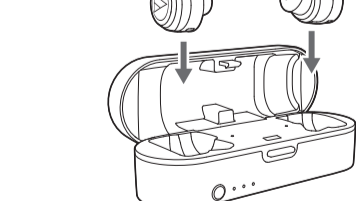

2

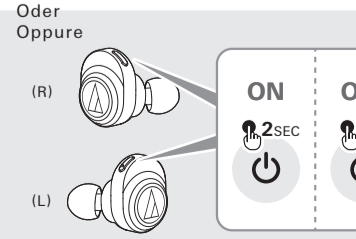
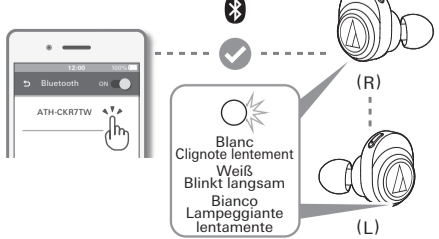

Musique / Téléphone / Musik / Handy / Musica / Telefono

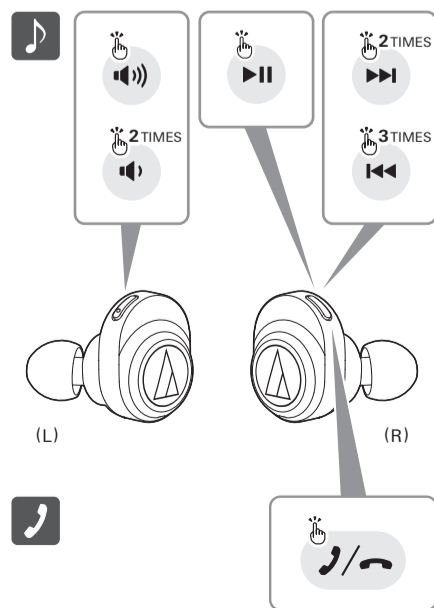

Informations / Informationen / Informazioni

Pour plus d'information sur les modalités d'utilisation de ce produit, rendez-vous sur le site Web Audio-Technica à l'URL indiquée ci-après et contenue dans le QR code.

Für weitere Informationen zur Nutzung dieses Produkts besuchen Sie die Audio-Technica-Website unter der unten angeführten und der im QR-Code enthaltenen URL.

Per maggiori informazioni su come utilizzare questo prodotto, consultare il sito di Audio-Technica all' URL indicato di seguito incluso nel codice QR.

www.audio-technica.com

Pour piloter le produit plus aisément, utilisez notre application pour smartphones.

Für eine bequemere Bedienung des Produkts nutzen Sie unsere App für Smartphones.

Per un miglior controllo del prodotto, utilizzare la app per smartphone dedicata.

✓ Comprobar / Conteúdo da embalagem / Проверка

- Auriculares / Fones de ouvido / Наушники
- Estuche de carga / Estujo de carregamento / Чехол-аккумулятор
- Puntas de audífono (XS, S, M, L) / Ponteiros (PP, P, M, G) / Насадки (размеры XS, S, M, L)
- Soporte de bucle 3D / Aro de soporte 3D / Вкладыши для эффекта объемного звучания
- Cable de carga USB / Cabo de carga USB / USB-кабель для зарядки
- Guía de inicio rápido (este folleto) / Guia rápido (este folheto) / Краткое руководство пользователя (этот листок)
- Guía de precauciones / Guia de precauções de segurança / Руководство по мерам предосторожности

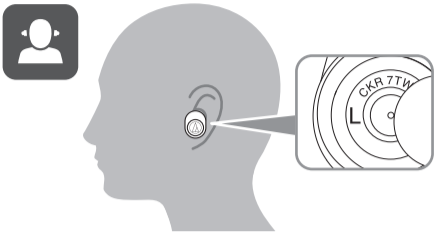

⚡ Carga / Carregar / Заряд

Estuche de carga / Estujo de carregamento / Чехол-аккумулятор

Micro USB Type-B USB Type-A

Auriculares / Fones de ouvido / Наушники

Blanco / Branco / Белый

Blanco / Branco / Белый

10 segundos después / Após 10 segundos / Через 10 секунд

Aragado / Desligar / Выкл.

📱 Emparejamiento / Emparelhamento / Сопряжение

1 ON

(L) (R)

Blanco / Parpadeando rápido / Branco / Piscando rapidamente / Белый / Быстрое мигание

2

(R) (L)

Blanco / Parpadeando lento / Branco / Piscando lentamente / Белый / Медленное мигание

Bluetooth

ATH-CKR7TW

O bien / Ou / или

(R) (L)

ON 2SEC OFF 4SEC

🎵 Música/Teléfono / Música/Telefone / Музыка/Телефон

2TIMES

2TIMES

2TIMES

3TIMES

3TIMES

(L) (R)

📖 Información / Informações / Информация

Para obtener más información sobre cómo usar este producto, visite el sitio web de Audio-Technica en la URL mostrada a continuación e incluida en el código QR.

Para obter mais informações sobre como usar este produto, visite o site da Audio-Technica no endereço listado abaixo e contido no código QR.

Для получения дополнительной информации по использованию этого изделия посетите веб-сайт компании Audio-Technica по адресу, указанному ниже, а также зашифрованному в QR-коде.

www.audio-technica.com

Para controlar con mayor comodidad el producto, utilice nuestra aplicación para smartphones.

Para maior comodidade no controle do produto, utilize nosso aplicativo para smartphones.

Для более удобного использования изделия воспользуйтесь нашим приложением для смартфонов.

✓ 检查 / 檢査 / 확인

- 耳机 / 耳機 / 이어폰
- 充电盒 / 充電盒 / 충전 케이스
- 耳套 (XS、S、M、L) / 耳塞 (XS、S、M、L) / 이어팁(XS, S, M, L)
- 3D辅助环 / 3D輔助環 / 3D 루프 서포트
- USB充电线 / USB充電線 / USB 충전 케이블
- 快速入门指南 (本说明书) / 快速入門指南 (本手冊) / 빠른 시작 가이드(본 소책자)
- 注意事项指南 / 注意事項 / 주의사항 안내

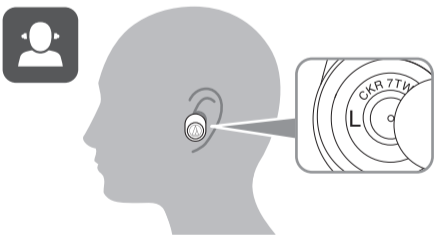

⚡ 充电 / 充電 / 충전

充电盒 / 充電盒 / 충전 케이스

Micro USB Type-B USB Type-A

耳机 / 耳機 / 이어폰

白色 / 白色 / 흰색

白色 / 白色 / 흰색

10秒钟后 / 10秒鐘後 / 10초 후

关闭 / 關閉 / 꺼짐

📱 配对 / 配對 / 페어링(연결)

1 ON

(L) (R)

白色 / 快速闪烁 / 白色 / 快速閃爍 / 흰색 / 빠르게 깜박임

2

(R) (L)

白色 / 慢速闪烁 / 白色 / 緩慢閃爍 / 흰색 / 천천히 깜박임

Bluetooth

ATH-CKR7TW

或 / 또는

(R) (L)

ON 2SEC OFF 4SEC

🎵 音乐/电话 / 音樂/電話 / 음악/전화

2TIMES

2TIMES

2TIMES

3TIMES

3TIMES

(L) (R)

📖 信息 / 資訊 / 정보

更多关于如何使用本产品的信息，请通过下列网址或扫描二维码访问“铁三角”网站。

欲獲得本產品的詳細使用方法，請掃描下方 QR code 或直接透過網址連接至「鐵三角」網站。

본 제품의 사용법에 관한 자세한 사항은 아래의 URL과 QR 코드에 있는 Audio-Technica 웹사이트에서 확인할 수 있습니다.

www.audio-technica.com

为了更方便地控制本产品，请使用我们针对智能手机的应用程序。

為了更方便控制本產品，請使用我們的智慧型手機應用程式。

더욱 간편하게 제품을 조작하려면 스마트폰용 앱을 사용하십시오.